

BLACKMER POWER PUMPS

966909

INSTRUCTIONS NO. 106-A00

INSTALLATION OPERATION AND MAINTENANCE INSTRUCTIONS

MODELS: MLX4B, MLXW4B, MRLX4B, MRLXW4B

MLN4B, MRLN4B

Section
Effective
Replaces

106
Jan 2014
Aug 2010

SAFETY DATA

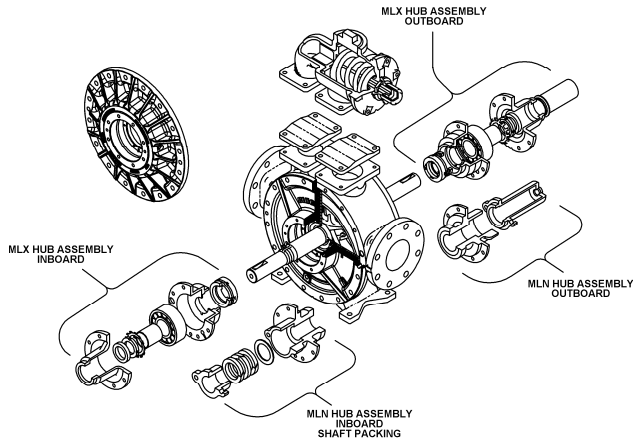

TABLE OF CONTENTS

Page

PUMP DATA

Technical Data	2
Initial Pump Start Up Information.....	2

INSTALLATION

Pre-Installation Cleaning	3
Location and Piping.....	3
Pump Mounting.....	3
Coupling Alignment.....	4
Pump Rotation.....	4
To Reverse Pump Rotation	4
Check Valves	4
Optional Jacketed Heads	4
Manual Bypass Valve.....	4

OPERATION

Pre-Start Up Check List.....	5
Start Up Procedures.....	5
Running the Pump in Reverse Rotation	5
Flushing the Pump	6
Pump Relief Valve.....	6
Relief Valve Setting and Adjustment	6

MAINTENANCEM(R)LX(W)4B.....M(R)LN4B

Lubrication	7	12
Vane Replacement	8	12
Pump Disassembly	8	13
Pump Assembly	9	14

TROUBLE SHOOTING 16 |

NOTE: Numbers in parentheses following individual parts indicate reference numbers on Blackmer Parts List No. 106-A01 for MLX4B, MLXW4B, MRLX4B, MRLXW4B and 106-A02 for MLN4B, MRLN4B.

Blackmer pump manuals and parts lists may be obtained from Blackmer's website (www.blackmer.com) or by contacting Blackmer Customer Service.



This is a SAFETY ALERT SYMBOL.

When you see this symbol on the product, or in the manual, look for one of the following signal words and be alert to the potential for personal injury, death or major property damage



Warns of hazards that **WILL** cause serious personal injury, death or major property damage.



Warns of hazards that **CAN** cause serious personal injury, death or major property damage.



Warns of hazards that **CAN** cause personal injury or property damage.

NOTICE:

Indicates special instructions which are very important and must be followed.

NOTICE:

Blackmer Pumps **MUST** only be installed in systems, which have been designed by qualified engineering personnel. The system **MUST** conform to all applicable local and national regulations and safety standards.

This manual is intended to assist in the installation and operation of the Blackmer ML4B Series pumps, and **MUST** be kept with the pump.

Pump service shall be performed by qualified technicians **ONLY**. Service shall conform to all applicable local and national regulations and safety standards.

Thoroughly review this manual, all instructions and hazard warnings, **BEFORE** performing any work on the pump.

Maintain **ALL** system and pump operation and hazard warning decals.

SAFETY DATA

⚠ WARNING



Hazardous machinery can cause serious personal injury.

Failure to disconnect and lockout electrical power before attempting maintenance can cause shock, burns or death

⚠ WARNING



Hazardous voltage. Can shock, burn or cause death.

Failure to disconnect and lockout electrical power before attempting maintenance can cause shock, burns or death

⚠ WARNING



Hazardous machinery can cause serious personal injury.

Failure to stop the pump before adjusting the shaft packing can cause severe personal injury.

⚠ WARNING



Hazardous pressure can cause personal injury or property damage

Disconnecting fluid or pressure containment components during pump operation can cause serious personal injury, death or major property damage

⚠ WARNING



Hazardous or toxic fluids can cause serious injury.

If pumping hazardous or toxic fluids, system must be flushed and decontaminated, inside and out, prior to performing service or maintenance

⚠ WARNING



Hazardous pressure can cause personal injury or property damage

Failure to relieve system pressure prior to performing pump service or maintenance can cause personal injury or property damage.

⚠ WARNING



Do not operate without guard in place

Operation without guards in place can cause serious personal injury, major property damage, or death.

PUMP DATA

PUMP IDENTIFICATION: A pump identification tag, containing the pump serial number, I.D. number, and model designation, is attached to each pump. Record and file the data from this tag for future reference. If replacement parts are needed, or if information pertaining to the pump is required, this data must be furnished to a Blackmer representative.

MLX4B – Full size liner, External Ball Bearings	MLXW4B – MLX4B w/ Wear resistant liner and discs
MRLX4B – MXL4B w/ Reduced Capacity Liner	MRLXW4B – MRLX4B w/ Wear resistant liner and discs
MLN4B – Full size liner, Sleeve Bearings (Bushings)	MRLN4B – MLN4B w/ Reduced Capacity Liner

TECHNICAL DATA

	MLX4B, MLXW4B MRLX4B, MRLXW4B	MLN4B, MRLN4B
Maximum Pump Speed	600 RPM	600 RPM
Max. Operating Temperature *	240 – 400°F (115 – 204°C)	240 – 400°F (115 – 204°C)
Maximum Viscosity *	30,000 – 100,000 SSU (6,300 – 21,000 cSt)	30,000 – 500,000 SSU (6,300 – 108,000 cSt)
Max. Differential Pressure	200 psi (13.8 Bar)	150 psi (10.3 Bar)
Max. Working Pressure	250 psi (17.2 Bar)	200 psi (13.8 Bar)

INITIAL PUMP START UP INFORMATION

Model No.:	_____
Serial No.:	_____
ID No.:	_____
Date of Installation:	_____
Inlet Gauge Reading:	_____
Discharge Gauge Reading:	_____
Flow Rate:	_____

* Maximum operating limits are dependent on the materials of construction. See Blackmer Material Specs 106-091, 106-093.

INSTALLATION

NOTICE:

Blackmer pumps must only be installed in systems designed by qualified engineering personnel. System design must conform with all applicable regulations and codes and provide warning of all system hazards.

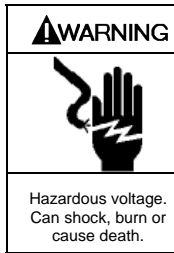

- ⚠ Install, ground and wire to local and National Electrical Code requirements.
- ⚠ Install an all-leg disconnect switch near the unit motor.
- ⚠ Disconnect and lockout electrical power before installation or service
- ⚠ Electrical supply **MUST** match motor nameplate specifications.

⚠ **Motors equipped with thermal protection automatically disconnect motor electrical circuit when overload exists. Motor can start unexpectedly and without warning.**

PRE-INSTALLATION CLEANING

NOTICE:

New pumps contain residual test fluid and rust inhibitor. If necessary, flush pump prior to use.

Foreign matter entering the pump WILL cause extensive damage. The supply tank and intake piping MUST be cleaned and flushed prior to pump installation and operation.

LOCATION AND PIPING

Pump life and performance can be significantly reduced when installed in an improperly designed system. Before starting the layout and installation of the piping system, review the following suggestions:

1. Locate the pump as near as possible to the source of supply to avoid excessive inlet pipe friction.
2. The inlet line must be at least as large as the intake port on the pump. It should slope downward to the pump and must not contain any upward loops. Eliminate restrictions such as sharp bends; globe valves, unnecessary elbows, and undersized strainers.
3. Install a strainer in the inlet line to protect the pump from foreign matter. Locate the strainer at least 24" (0.6m) from the pump, and have a net open area of at least four times the area of the intake piping. Strainers must be cleaned regularly to avoid pump starvation.
4. The intake system must be free of air leaks.
5. Expansion joints, placed at least 36" (0.9m) from the pump, will compensate for expansion and contraction of the pipes. Contact the flexible connector/hose manufacturer for required maintenance/care and design assistance in their use.
6. Install pressure gauges in the NPT ports provided in the pump casing to check pump at start up.
7. ALL piping and fittings MUST be properly supported to prevent any piping loads from being placed on the pump.

8. Check alignment of pipes to pump to avoid strains which might later cause misalignment. See Figure 1. Unbolt flanges or break union joints. Pipes must not spring away or drop down. After pump has been in operation for a week or two, completely recheck alignment.

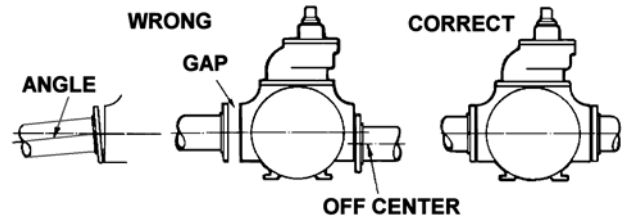

Figure 1

9. When pumping liquids at elevated temperature, make provisions to compensate for expansion and contraction of the pipes, especially when long pipe lines are necessary. Steel pipe expands approximately 3/4" (1.9 cm) per 100 feet (30.49 m) per 100°F (37.8°C) rise in temperature.

PUMP MOUNTING

A solid foundation reduces noise and vibration, and will improve pump performance. On permanent installations it is recommended the pumping unit be secured by anchor bolts as shown in Figure 2. This arrangement allows for slight shifting of position to accommodate alignment with the mounting holes in the base plate.

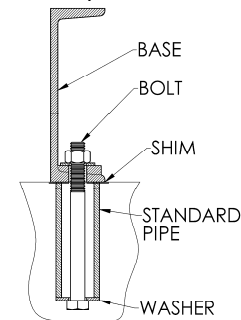

Figure 2 - Pipe Type Anchor Bolt Box

For new foundations, it is suggested that the anchor bolts be set in concrete. On existing concrete floors, drill holes into the concrete to hold the anchor bolts.

When installing units built on channel or structural steel type bases, use care to avoid twisting the base out of shape when anchor bolts are tightened. Use shims under the edges of the base prior to tightening of the anchor bolts to level the base and prevent distortion.

INSTALLATION

COUPLING ALIGNMENT

The pump must be directly coupled to a gear and/or driver with a flexible coupling. Verify coupling alignment after installation of new or rebuilt pumps. Both angular and parallel coupling alignment **MUST** be maintained between the pump, gear, motor, etc. in accordance with manufacturer's instructions. See Figure 3.

1. Parallel alignment: The use of a laser alignment tool or dial indicator is preferred. If a laser alignment tool or dial indicator is not available, use a straightedge. Turn both shafts by hand, checking the reading through one complete revolution. Maximum offset must be less than .005" (125 microns).
2. Angular alignment: Insert a feeler gauge between the coupling halves. Check the spacing at 90° increments around the coupling (four checkpoints). Maximum variation must not exceed .005" (125 microns). Some laser alignment tools will check angular alignment as well.
3. Replace the coupling guards after setting alignment.

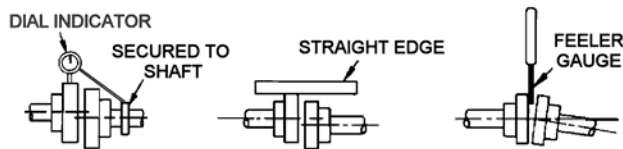
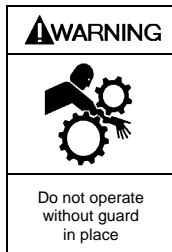

Figure 3 – Alignment Check



Operation without guards in place can cause serious personal injury, major property damage, or death.

Do not operate
without guard
in place

PUMP ROTATION

A right-hand pump rotates clockwise with the intake on the right side, when viewed from the driven end.

A left-hand pump rotates counterclockwise with the intake on the left side, when viewed from the driven end.

TO REVERSE PUMP ROTATION

ML4B Series pumps have double-ended shafts, allowing the pump to be driven from either end. Rotation is changed by reversing the position of the pump assembly. To do so, rotate the pump 180 degrees so that the opposite shaft becomes the driven shaft.

CHECK VALVES

The use of check valves or foot valves in the supply tank is not recommended with self-priming, positive displacement pumps.

If the possibility of liquid backflow exists when the pump is off, a check valve in the pump discharge piping is recommended because the pump can motor in the reverse rotation and create undue stress on all attached components. Never start a pump when it is rotating in the reverse rotation as the added starting torque can damage the pump and related equipment.

OPTIONAL JACKETED HEADS

Hot oil or steam can be circulated through jacketed heads by connections at the ½" NPT pipe plugs directly above and below the shaft for heating highly viscous liquids, or to "thaw out" liquids which have congealed in the pumping chamber and packing area. Maximum recommended steam pressure is 150 psi (10.3 bar).

Make sure heat is applied early enough to sufficiently thin the liquid before starting the pump. Liquids that congeal in the relief valve chamber will make the valve inoperative. Insulation of the pump with sufficient heat to the jackets will usually thin the liquid in the relief valve chamber. Take precautions to ensure the valve has free movement. It is advisable to start the pump with an open discharge.

MANUAL BYPASS VALVE

WARNING

Excessive discharge pressure can result in damage to the pump or personal injury. In order to control system pressure, a bypass valve or other pressure limiting device must be installed in the discharge pumping system.

A bypass line from the pump discharge to the pump suction, with a manual shut-off valve, is recommended when handling volatile liquids, viscous liquids at a high lift, or when delivering to piping too small to take the full flow from the pump. For example:

1. When handling very viscous liquids, excessive pressure may develop when starting the pump. To avoid possible damage to the pump, open the bypass valve before starting. After the pressure stabilizes and the pump is running smoothly, close the valve slowly.
2. When liquids are pumped under a high suction lift, cavitation may result, causing the pump to become very noisy and begin vibrating. By cracking the manual bypass valve open, and permitting some of the liquid to recirculate, the noise and vibration can be reduced to an acceptable level. See other causes of noise and vibration in the "General Pump Troubleshooting" Section.

NOTE: With a 4" size pump, a 2" manual bypass valve and recirculation line is recommended.

OPERATION

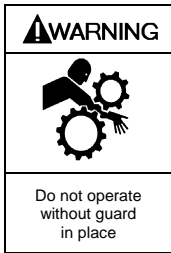

Operation without guards in place can cause serious personal injury, major property damage, or death.



Disconnecting fluid or pressure containment components during pump operation can cause serious personal injury, death or major property damage

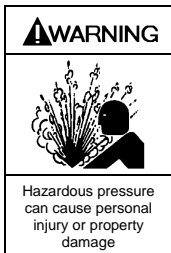

Failure to relieve system pressure prior to performing pump service or maintenance can cause personal injury or property damage.

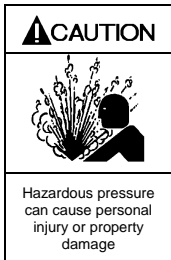

Pumps operating against a closed valve can cause system failure, personal injury and property damage

PRE-START UP CHECK LIST

1. Check the alignment of the pipes to the pump. Support pipes so that they do not spring away or drop down when pump flanges or union joints are disconnected.
2. Verify proper coupling alignment.
3. Blackmer helical gear reducers (if supplied) are shipped from the factory without oil in the gearcase. Fill with the grade of oil indicated on the reducer tag. For more specific instructions on Blackmer gear reducers, refer to the appropriate Gear reducer Installation, Operation and Instruction Manual.
4. Check the entire pumping system to verify that the proper inlet and discharge valves are fully open, and that the drain valves and other auxiliary valves are closed.
5. Install vacuum and pressure gauges on the pump in the 1/4" NPT connections provided. These can be used to check actual suction and discharge conditions after pump start-up.
6. Check the wiring of the motor, and briefly turn on the power to make sure that the pump rotates in the direction of the rotation arrow.

START UP PROCEDURES

NOTICE:

Consult the "General Pump Troubleshooting" section of this manual if difficulties during start up are experienced.

1. Start the motor. Priming should occur within one minute.
2. Check the vacuum and pressure gauges to see if the pump is operating within the expected conditions.
3. Check for leakage from the piping and equipment.
4. Check for excessive noise, vibration or overheating of the pump, reducer, and motor.
5. If possible, check the flow rate.
6. Check the pressure setting of the relief valve by briefly closing a valve in the discharge line and reading the pressure gauge. This pressure must be at least 15 - 20 psi (1.0 - 1.4 bar) higher than the maximum operating pressure.

CAUTION: Do not run the pump for more than 10-15 seconds with the discharge valve completely closed.

If adjustments need to be made, refer to "Relief Valve Setting & Adjustment."

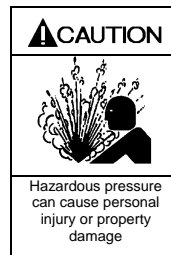

Incorrect settings of the pressure relief valve can cause pump component failure, personal injury, and property damage.

RUNNING THE PUMP IN REVERSE ROTATION

NOTICE:

Do not operate the pump in reverse rotation for no more than 10 minutes and only when a separate pressure relief valve is installed to protect the pump from excessive pressure.

It may be desirable to run the pump in reverse rotation for system maintenance. The pump will operate satisfactorily in reverse rotation for a LIMITED time, at a reduced performance level.

OPERATION

FLUSHING THE PUMP

NOTICE:

If flushing fluid is to be left in the pump for an extended time, it must be a lubricating, non-corrosive fluid. If a corrosive or non-lubricating fluid is used, it must be flushed from the pump immediately.

1. To flush the pump, run the pump with the discharge valve open and the intake valve closed. Bleed air into the pump through the intake gauge plug hole or through a larger auxiliary fitting in the intake piping. Pump air for 30 second intervals to clean out most of the pumpage.
2. Run a system compatible flushing fluid through the pump for one minute to clear out the remainder of the original pumpage.
3. To remove the flushing fluid, follow step 1 above.

NOTICE:

After flushing the pump some residual fluid will remain in the pump and piping.

NOTICE:

Properly dispose of all waste fluids in accordance with the appropriate codes and regulations.

PUMP RELIEF VALVE

WARNING

Internal bypassing of liquid elevates liquid temperature. Use the internal bypass valve for brief periods only and at differential pressures below 125 psi (8.6 bar). For extended periods or higher pressures, the internal bypass port must be plugged and the liquid returned back to the source.

The ML4 Series pump is offered with an optional relief valve assembly which is bolted onto the pump casing. The valve may be used as an internal relief valve, or as an external bypass, piped back to the storage tank (see Figure 4). Its purpose is to protect the pump or pumping system from excessive pressure. The valve is not meant to be used for prolonged recirculation.

When pumping highly volatile liquids under a high suction lift, and cavitation or starving of the pump exists, partial closing of the discharge valve will result in excessive noise in the relief valve. Plumbing the relief valve so flow is directed back to the storage tank is recommended when operating under these conditions.

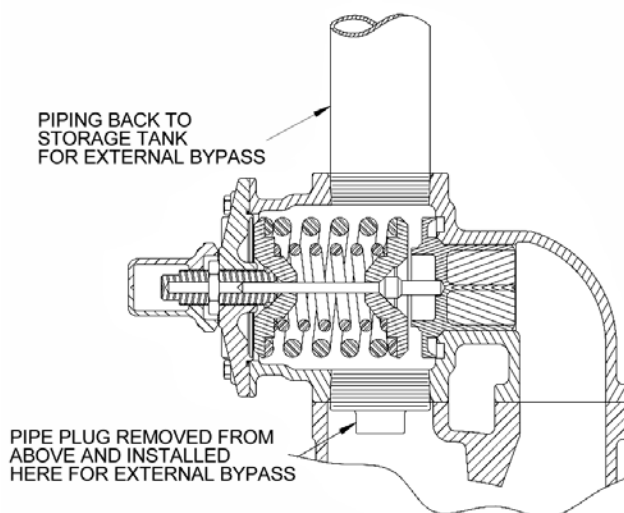
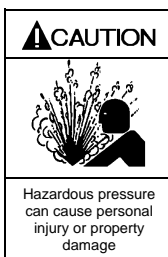

Figure 4 – Relief Valve

RELIEF VALVE SETTING AND ADJUSTMENT

The relief valve pressure setting is marked on a metal tag attached to the valve cover. Set the relief valve at least 15 - 20 psi (1.0 - 1.4 Bar) higher than the operating pressure, or the external bypass valve setting (if equipped).



Incorrect settings of the pressure relief valve can cause pump component failure, personal injury, and property damage.

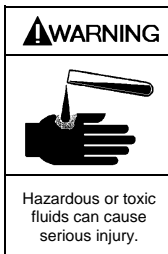

Relief valve cap is exposed to pumpage and will contain some fluid

DO NOT remove the R/V Cap OR adjust the relief valve pressure setting while the pump is in operation.

1. To **INCREASE** the pressure setting, remove the relief valve cap(1), loosen the locknut(3), and turn the adjusting screw(2) *inward*, or clockwise. Replace the valve cap.
2. To **DECREASE** the pressure setting, remove the relief valve cap(1), loosen the locknut(3), and turn the adjusting screw(2) *outward*, or counterclockwise. Replace the valve cap.

Refer to the individual Blackmer pump parts lists for various spring pressure ranges. Unless specified otherwise, pumps are supplied from the factory with the relief valve adjusted to the mid-point of the spring range.

MAINTENANCE: MLX4B, MLXW4B, MRLX4B, MRLXW4B

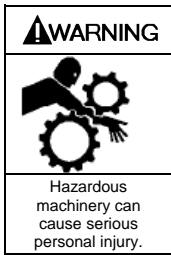

Failure to disconnect and lockout electrical power before attempting maintenance can cause shock, burns or death

Hazardous machinery can cause serious personal injury.

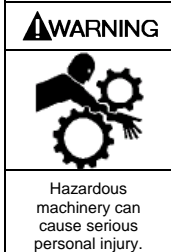

Failure to stop the pump before adjusting the shaft packing can cause severe personal injury.

Hazardous machinery can cause serious personal injury.

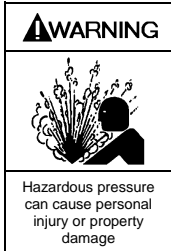

Failure to relieve system pressure prior to performing pump service or maintenance can cause personal injury or property damage.

Hazardous pressure can cause personal injury or property damage

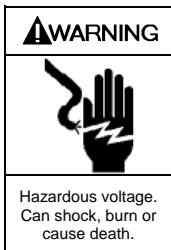

Failure to disconnect and lockout electrical power before attempting maintenance can cause shock, burns or death

Hazardous voltage. Can shock, burn or cause death.



Disconnecting fluid or pressure containment components during pump operation can cause serious personal injury, death or major property damage

Hazardous pressure can cause personal injury or property damage

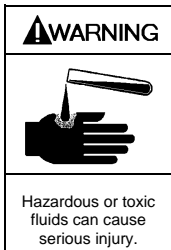

If pumping hazardous or toxic fluids, system must be flushed and decontaminated, inside and out, prior to performing service or maintenance

Hazardous or toxic fluids can cause serious injury.

SCHEDULED MAINTENANCE

STRAINERS

Strainers must be cleaned regularly to avoid pump starvation. Schedule will depend upon the application and conditions.

LUBRICATION

NOTICE:

To avoid possible entanglement in moving parts do not lubricate pump bearings, gear reducer or any other parts while the pump is running.

NOTICE:

If pumps are repainted in the field, ensure that the grease relief fittings (76A) are functioning properly after painting. Do NOT paint them closed. Remove any excess paint from the fittings.

Lubricate pump bearings every one to twelve weeks (AT MINIMUM), depending on the application, and operating conditions.

Recommended Grease – Non-jacketed pumps:

*Mobil® - Mobilgrease XHP222,
Exxon® - RONNEX MP Grease,
or equivalent.*

Recommended Grease – Jacketed pumps:

Exxon® - Polyres, or Mobil® - MOBIL Poly 372, or equivalent Polyurea grease.

Greasing Procedure:

1. Remove the grease relief fittings (76A) from the bearing covers (27A).
2. **SLOWLY** apply grease with a hand gun until grease begins to escape from the grease relief fitting port.
3. Replace the grease relief fittings (76A).

DO NOT overgrease pump bearings. While it is normal for some grease to escape from the grease tell-tale hole after lubrication, excessive grease on pumps equipped with mechanical seals can cause seal failure.

IF EQUIPPED: Blackmer gear reducers are shipped from the factory without oil in the gearcase. Fill with the grade of oil indicated on the reducer tag. Change the oil after the first 48 hours of use, and approximately every 500 hours of use thereafter.

NOTICE:

Maintenance shall be performed by qualified technicians only, following the appropriate procedures and warnings as presented in this manual.

VANE REPLACEMENT

NOTICE:

Maintenance shall be performed by qualified technicians only, following the appropriate procedures and warnings as presented in manual.

1. Remove the head assembly (20 or 20A) and all other parts on the outboard (non-driven) side of the pump according to Steps 1 through 9 of the "Pump Disassembly" Section.
2. Turn the shaft by hand until a vane (14) comes to the top (12 o'clock) position of the rotor.
3. Remove and replace the vane, making sure to install the vane with the rounded edge outward to contact the liner (41).
4. Rotate the shaft until the next rotor slot is in the top position, and replace the vane.
5. Continue this procedure until all new vanes are in place.
6. Reassemble the pump per "Pump Assembly."

PUMP DISASSEMBLY

NOTICE:

Follow all hazard warnings and instructions provided in the "Maintenance" section of this manual.

NOTE: The numbers in parentheses following individual parts indicate reference numbers on the coinciding Parts List.

1. Remove the bearing cover capscrews (28) and slide the bearing cover (27) from the shaft, being careful not to cut the inserted grease seal (104) on the shaft keyway.
2. Remove the bearing preload wave spring (24C).
3. Bend up the lockwasher tang (24B) engaged in the locknut (24A), and turn the locknut counterclockwise to remove it from the shaft. Slide the lockwasher off the shaft.
4. Make sure the shaft is free of any dirt, nicks or burrs which may cause seal O-ring damage when removing the hub assembly and rotating seal face.
5. Remove the hub capscrews (21D). To disengage the hub assembly from the head, two jackscrew holes are provided in the rim of the hub. Slide the hub assembly off the shaft with the bearing, stationary seat, and stationary O-ring still intact. Once the hub assembly has been removed from the head, the bearing and stationary seat can be removed from the hub.
 - a. Slide the bearing (24) out of the bearing cavity.
 - b. Using a blunt instrument, push or gently tap the backside (non-polished side) of the stationary seat (153A) to remove it from the seal recess. Place a cloth under the seal to avoid damage. Be careful not to contact the polished surface of the seal face during removal.
6. With the use of wire hooks, carefully pull the rotating seal assembly (jacket, seal face & O-ring) (153B & 153E) out of the head and off the shaft. Holes in the seal jacket will facilitate the removal.
7. Remove the head capscrews (21) and head stud nuts (21C). Two jackscrew holes are provided in the rim of the head to facilitate removal.
8. Remove the head (20 or 20A) from the casing (12), being careful not to nick or scrape the shaft.

9. The disc (71) will come off with the head assembly and is attached with four countersunk, allen-head machine screws (71A) and lockwashers (71B).
10. In order to remove the rotor and shaft assembly without damaging the mechanical seal, it is advisable to remove the second hub assembly and mechanical seal components from the opposite side of the pump. Follow Steps 1 through 7.
11. From the open side of the pump, grasp the rotor in the 3 and 9 o'clock positions, and gently pull the rotor and shaft (13) out of the head assembly remaining on the casing. CAUTION: Use care to avoid injury, the rotor and shaft is heavy and may have sharp edges.
12. The remaining head assembly can now be easily removed. Follow Steps 8 through 10.
13. Depending on the pump application, the liner (41) can be removed in two ways:
 - a. If the pumpage is a clean, non-corrosive liquid, with low viscosity, the liner can usually be withdrawn from the casing by prying with two bars. Insert the tips of the bars into the port openings on either side of the liner, and partially remove the liner by prying against the rotor. Use a block under the bar, against the rotor, to bring the liner the rest of the way out (see Figure 5).
 - b. If the pumpage is corrosive, contains a large concentration of particulate matter, or is high viscosity, the liner will most likely have to be driven out the casing, rather than pried out. To do so, use a brass or hard wood drift and a hammer and tap around the diameter of the liner until it is driven out of the casing.

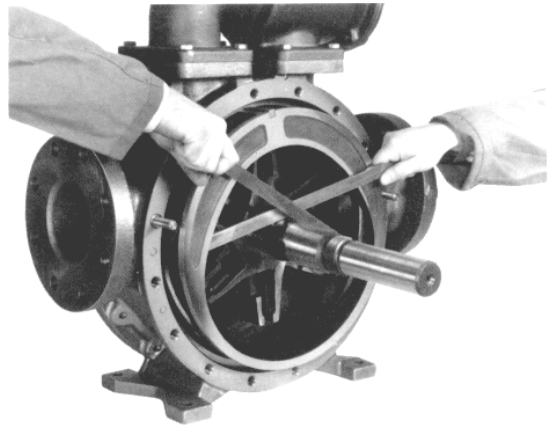

Figure 5 – Liner Removal

PARTS REPLACEMENT

1. If any of the O-rings have been removed or disturbed during disassembly, they must be replaced with new O-rings. **NOTE:** Heat PTFE O-rings in hot water to aid installation.
2. Excessive or continuous leakage from the tell-tale hole in the bearing cover may be an indication of a damaged mechanical seal. If a mechanical seal has been leaking, it is recommended the entire seal be replaced. Refer to "General Pump Troubleshooting" for possible causes of seal leakage.

PUMP ASSEMBLY

Before reassembling the pump, inspect all component parts for wear or damage, and replace as required. Wash out the bearing/seal recess of the head and remove any burrs or nicks from the rotor and shaft. Remove any burrs from the liner (41).

1. **LINER** – The liner (41) has a close fit with the casing (12); take care to avoid finger injury during installation.
 - a. Align and start the liner (41) and liner key (74) together into the pump casing (12). The word "INTAKE," which is cast into the liner, must be towards the intake side of the pump. **NOTE:** The intake port is marked with an inward facing arrow.
 - b. Lightly tap the outer edge of the liner with a plastic or lead hammer to fully insert it into the casing.
2. **DISC** – Before the disc is attached to the head, make sure both surfaces are clean and smooth. Gently file away any burrs or rough spots.
 - a. Place a disc (71) on the head (20 or 20A) with the counterbored screw holes facing up.
 - b. Position the disc so that **when the head is mounted** with the drain hole and V-notch down, the word "INTAKE" on the disc will be towards the intake side of the pump. The two disc holes must be in the 2 and 4 o'clock positions if the inlet is on the right (see Figure 6).
 - c. Install the four lockwashers (71B), tangs outward, and machine screws (71A) to attach the disc to the head.

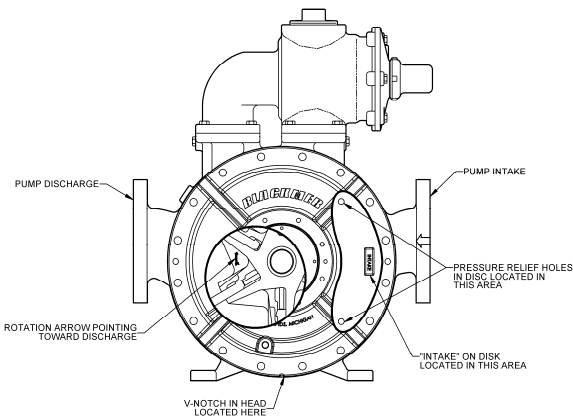

Figure 6

3. HEAD ASSEMBLY

- a. To mount the head assembly (20 or 20A) to the casing, first install the head O-ring (72) in the groove formed where the disc meets the head.
- b. Grease the chamfer on the pump casing where the head O-ring will need to slide into position.
- c. Place the head assembly (20 or 20A) on the studs, with the V-notch and drain hole facing down (towards the bottom of the pump).
- d. Check to make sure the word "INTAKE" on the disc is towards the intake side of the pump when the head is mounted.
- e. Install and tighten the two nuts (21C) on the head studs.
- f. Install and tighten the head capscrews (21) uniformly, making sure the head O-ring (72) slides into place without damage.

4. Attach one hub (20C) and bearing (24) to the mounted head without O-rings or mechanical seal components. Install and snug up the hub capscrews (21D).
NOTE: This step is intended as an assembly aid and is essential to help guide the rotor and shaft into place without damaging the mechanical seal. The remaining parts of the hub will be installed later. **BEGIN WORKING ON THE OPPOSITE SIDE OF THE PUMP.**
5. **ROTOR AND SHAFT**
It is necessary to install the bottom vanes and the push rods in the rotor while inserting the rotor and shaft into the pump casing.

- a. Partially install the rotor and shaft (13) into the open side of the pump and through the bore of the installed head (20 or 20A). Be careful not to damage the disc face with the shaft end.
NOTE: When installing the rotor and shaft, the rotation arrow on the rotor must point in the direction of pump rotation-towards the discharge side of the pump when the arrow is positioned directly below the shaft. See Figure 6.
- b. Keep part of the rotor (13) outside the casing (12) such that the three bottom vanes (14) (rounded edge outward) can be inserted into the rotor slots and held in place while all three push rods (77) are inserted. See Figure 7.
- c. The rotor and shaft (13), with the three bottom vanes (14) installed, can now be **fully** inserted into the casing (12).
- d. Install the remaining vanes (14) in the top positions of the rotor (13).

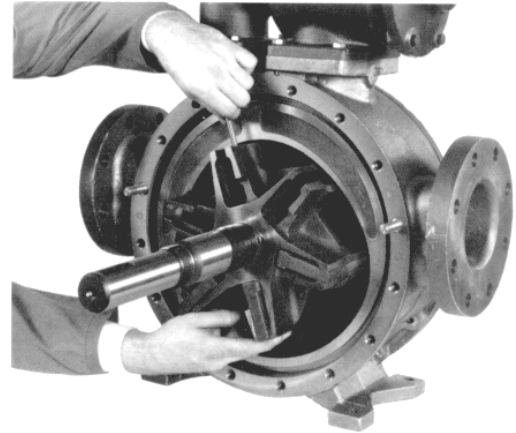

Figure 7

6. In order to lift and square the rotor against the previously installed head, it is necessary to temporarily install the bearing (24), bearing spacer (24D), and the locknut (24A) on the mounted head and hub assembly. This will position the rotor, and aid in installing the second head assembly.
 - a. Grease the bearing (24) and place it into the bearing housing in the hub (20C).
 - b. Slide the bearing spacer (24D) and locknut (24A) onto the shaft and snug up the locknut by hand.
7. Follow Steps 2 and 3 to install the remaining head assembly (including the head, head O-ring, and disc). Remember to grease the entire casing chamfer to help slide the head O-ring into place.

8. MECHANICAL SEAL

Rotating Assembly

- a. Make sure the shaft is free of burrs that might cut or nick the O-rings. Put a light film of grease on the shaft between the rotor and the shaft threads to facilitate seal installation.
- b. Slide the mechanical seal rotating assembly (153B & 153E) over the shaft with the drive tangs of the jacket towards the rotor, and the polished face outward.
- c. Rotate the jacket assembly to engage the drive tangs into the rotor slots. **IMPORTANT:** Failure to engage the drive tangs of the jacket assembly will cause seal damage when the hub is attached.
- d. Clean the rotating seal face with a clean tissue and alcohol.

Stationary Seat

- a. Put a light coating of grease in the seal recess of the hub.
- b. Align the locating pin in the stationary seat (153A) with the slot in the bottom of the hub recess.
- c. Insert the stationary seat (153A) and O-ring (153D) into the seal recess with the polished face outward.
- d. Clean the polished face with a clean tissue and alcohol. Bronze seal faces should be oiled during installation, but other seal faces must be kept clean and dry. Note: Carbon/PTFE rotating seal face (153B) is installed as a one-piece assembly.

9. HUB ASSEMBLY

- a. Before installing the second hub assembly, grease the three (3) head chamfers.
- b. Install the hub O-rings (72A & 72B), and slide the hub onto the shaft with the V-notch of the hub towards the bottom of the pump. Use extreme care to avoid damage to the seal face.
- c. Install and hand tighten the two hub capscrews (21D) to pull the hub into place.

10. BEARING AND BEARING SPACER

- a. Hand pack the bearing (24) with grease. See LUBRICATION section of this manual.
- b. Insert the greased bearing (24) into the bearing housing of the hub. Tap the outer edge of the bearing to ensure that it is properly seated.
- c. Slide the bearing spacer (24D) onto the shaft.

11. **Return to the first** head assembly and remove and reassemble the hub, this time including the mechanical seal and O-rings (see Step 8 for mechanical seal instructions). Lightly grease the shaft and the head chamfers before installing the assembly to enable the O-rings to slide into place without damage. Reinstall the bearing spacer (24D).

12. LOCKNUT INSTALLATION

The bearing locknuts (24A) and lockwashers (24B) **MUST** be installed and adjusted properly. Overtightening locknuts can cause bearing failure or a broken lockwasher tang. Loose locknuts will allow (See Figure 8) the rotor to shift against the heads, causing wear.

- a. On both ends of the pump shaft, Install a lockwasher (24B) with the tangs facing outward, followed by a locknut (24A) with the tapered end inward. Ensure the inner tang "A" of the lockwasher is located in the slot in the shaft threads, bending it slightly, if necessary.
- b. Tap outer edge of bearings (24) with soft mallet to ensure they are bottomed in the head recess. Tighten both locknuts (24A). **DO NOT** overtighten and bend or shear the lockwasher inner tang.
- c. Loosen both locknuts (24A) one complete turn.
- d. Tighten one locknut (24A) until a slight rotor drag is felt when turning the shaft by hand.
- e. Back off the nut the width of one lockwasher tang "B". Secure the nut by bending the closest aligned lockwasher tang into the slot in the locknut. The pump must turn freely when rotated by hand.
- f. Tighten the opposite locknut (24A) by hand until it is snug against the bearing (24). Then, using a spanner wrench, tighten the nut the width of one lockwasher tang. Tighten just past the desired tang, then back off the nut to align the tang with the locknut slot. Secure the nut by bending the aligned lockwasher tang into the slot in the locknut. The pump must continue to turn freely when rotated by hand.
- g. To check adjustment, grasp the nut and washer with fingers and rotate back and forth. If this cannot be done, one or both locknuts are too tight. Alternately loosen one stop at a time .001" (.025mm) until properly adjusted. Begin by loosening the locknut adjusted last.
- h. After adjustment is complete, remove the bearing cover capscrews and 3/8" washers from both ends of the pump.

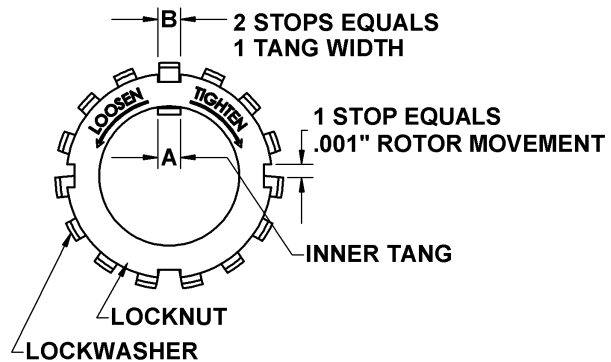

Figure 8 Locknut Adjustment

MAINTENANCE: M(R)LX(W)4B Series

13. GREASE SEAL

If the grease seal (104) has been removed from the bearing cover (27), it must be replaced prior to attaching the cover to the pump. Apply a small amount of grease to the outside diameter of the grease seal, and push it into the cavity of the bearing cover so that the lip of the seal will face inward (towards the pump) when the cover is attached.

14. BEARING COVER

Place the bearing preload wave spring (24C) against the outer bearing race. Install a bearing cover O-ring (26) into the groove in the bearing cover (27) and slide the cover over the shaft with the V-notch down. Install and tighten the bearing cover capscrews (28).

CAUTION: The pump MUST NOT be operated without the bearing covers bolted into place.

15. SHAFT PROTECTOR

Install and tighten the threaded shaft protector (185) into the bearing cover (27) on the non-driven end of the pump.

16. RELIEF VALVE ASSEMBLY (if equipped)

- a. Insert the valve (9) into the relief valve body (6) with the fluted end inward.
- b. Install the relief valve spring (8), spring guide (7) and guide rod (45) against the valve.
- c. Attach a new relief valve gasket (10) and the valve cover (4) on the cylinder.
- d. Screw the relief valve adjusting screw (2) into the valve cover until it makes contact with the spring guide (7).
- e. Install the relief valve cap (1) and gasket (88) after the relief valve has been precisely adjusted.

NOTICE:

The relief valve setting MUST be tested and adjusted more precisely before putting the pump into service. Refer to "Relief Valve Setting and Adjustment"

17. Reinstall coupling, shaft key (35), and coupling guards.

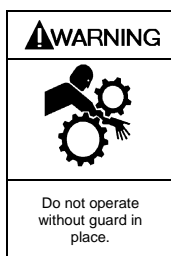

Operation without guards in place can cause serious personal injury, major property damage, or death.

18. Refer to "Pre-Start Up Check List" and "Start Up Procedures" sections of this manual prior to pump operation.

MAINTENANCE: PUMP MODEL: MLN4B, MRLN4B

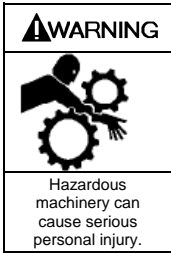

Failure to disconnect and lockout electrical power before attempting maintenance can cause shock, burns or death

Hazardous machinery can cause serious personal injury.

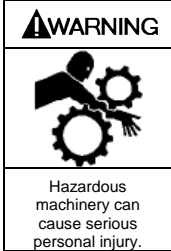

Failure to stop the pump before adjusting the shaft packing can cause severe personal injury.

Hazardous machinery can cause serious personal injury.

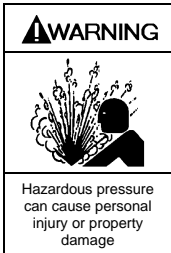

Failure to relieve system pressure prior to performing pump service or maintenance can cause personal injury or property damage.

Hazardous pressure can cause personal injury or property damage.

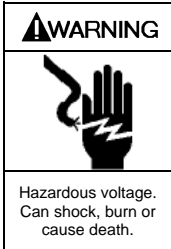

Failure to disconnect and lockout electrical power before attempting maintenance can cause shock, burns or death

Hazardous voltage. Can shock, burn or cause death.



Disconnecting fluid or pressure containment components during pump operation can cause serious personal injury, death or major property damage

Hazardous pressure can cause personal injury or property damage.

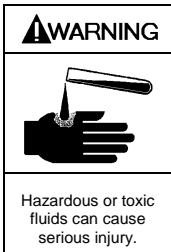

If pumping hazardous or toxic fluids, system must be flushed and decontaminated, inside and out, prior to performing service or maintenance

Hazardous or toxic fluids can cause serious injury.

NOTICE:

Maintenance shall be performed by qualified technicians only, following the appropriate procedures and warnings as presented in this manual.

SCHEDULED MAINTENANCE

STRAINERS

Strainers must be cleaned regularly to avoid pump starvation. Schedule will depend upon the application and conditions.

LUBRICATION

NOTICE:

To avoid possible entanglement in moving parts do not lubricate gear reducer or any other parts while the pump is running.

Sleeve bearings (bushings) are lubricated by the liquid being pumped. Additional lubrication is not required.

IF EQUIPPED: Blackmer gear reducers are shipped from the factory without oil in the gearcase. Fill with the grade of oil indicated on the reducer tag. Change the oil after the first 48 hours of use and approximately every 500 hours of use thereafter.

VANE REPLACEMENT

NOTICE:

Maintenance shall be performed by qualified technicians only. Following the appropriate procedures and warnings as presented in manual.

1. Remove the head assembly (20) and all other parts on the outboard (non-driven) side of the pump. See the "Pump Disassembly" Section.
2. Turn the shaft by hand until a vane (14) comes to the top (12 o'clock) position of the rotor.
3. Remove and replace the vane, making sure to install the vane with the rounded edge outward to contact the liner (41).
4. Rotate the shaft until the next rotor slot is in the top position, and replace the vane.
5. Continue this procedure until all new vanes are in place.
6. Reassemble the pump per "Pump Assembly."

PUMP DISASSEMBLY

NOTICE:

Follow all hazard warnings and instructions provided in the "Maintenance" section of this manual.

NOTE: The numbers in parentheses following individual parts indicate reference numbers on the Pump Parts List.

1. On the outboard (non-driven) side of the pump, remove the hub capscrews (21D). To disengage the outboard hub assembly (20C) from the head, two jackscrew holes are provided in the rim of the hub. Slide the hub assembly off the shaft with the shaft cover still intact.
NOTE: The sleeve bearing (24) is press fitted into the hub. Do not remove unless replacement is necessary (see "Sleeve Bearings").
2. Remove the two shaft cover capscrews (28) to release the shaft cover (27) and O-ring (26) from the hub assembly.
3. On the opposite (inboard) end of the pump, clean the pump shaft thoroughly, making sure the shaft is free of nicks, burrs, or paint that might damage the packing or mechanical seal when the inboard hub is removed.
4. **PUMPS EQUIPPED WITH PACKING**
 - a. Back off the packing removal nuts (18A) to reduce packing friction.
 - b. Remove the inboard hub capscrews (21D). Two jackscrew holes are provided in the rim of the inboard hub to facilitate removal.
 - c. Slide the packing follower (75) and hub assembly (20C) together off the shaft.
 - d. Remove the packing follower (75) removal nuts (18) and pull the follower out of the hub assembly.
 - e. The packing rings (19) and packing washer (58) can be pulled from the inboard hub with the use of a corkscrew tool or screwdriver.

NOTE: On pumps equipped with **Blackmer Triple-Lip Seal** or a **commercial mechanical seal**, loosen all setscrews before removing the hub assembly. For further instructions on the disassembly and assembly of commercial mechanical seals, refer to the separate literature accompanying the mechanical seal.

5. Remove the head capscrews (21) and head stud nuts (21C). Two jackscrew holes are provided in the rim of the head to facilitate removal.
6. Remove the head (20 or 20A) from the casing (12), being careful not to nick or scrape the shaft.
7. The disc (71) will come off with the head assembly and is attached with four countersunk, allen-head machine screws (71A) and lockwashers (71B).
8. From the open side of the pump, grasp the rotor in the 3 and 9 o'clock positions, and gently pull the rotor and shaft (13) out of the head assembly remaining on the casing. **CAUTION:** Use care to avoid injury-the rotor and shaft is heavy and may have sharp edges.
9. The remaining head assembly can now be easily removed. Follow Steps 6 through 8.

10. Depending on the pump application, the liner (41) can be removed in two ways:
 - a. If the pumpage is a clean, non-corrosive liquid, with low viscosity, the liner can usually be withdrawn from the casing by prying with two bars. Insert the tips of the bars into the port openings on either side of the liner, and partially remove the liner by prying against the rotor. Use a block under the bar, against the rotor, to bring the liner the rest of the way out (see Figure 9).

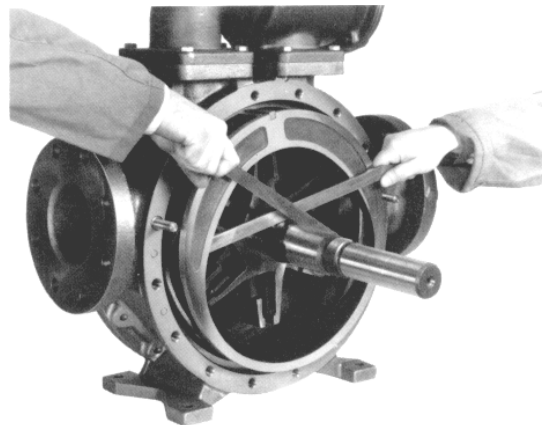

Figure 9 – Liner Removal

- b. If the pumpage is corrosive, contains a large concentration of particulate matter, or is high viscosity, the liner will most likely have to be driven out of the casing, rather than pried out. To do so, use a brass or hard wood drift and a hammer and tap around the diameter of the liner until it is driven out of the casing.

PARTS REPLACEMENT

1. If any of the O-rings have been removed or disturbed during disassembly, they must be replaced with new O-rings. **NOTE:** Heat PTFE O-rings in hot water to aid installation.
2. Excessive or continuous leakage around the pump shaft may be an indication of a damaged mechanical seal, worn packing, or a damaged or worn sleeve bearing.
 - a. If a mechanical seal has been leaking, it is recommended the entire seal be replaced. Refer to "General Pump Troubleshooting" for possible causes of seal leakage.
 - b. If the packing is leaking excessively, refer to "Packing Adjustment." If this does not solve the problem, install a complete new set of packing rings.
 - c. If the pump shaft indicates an excessive amount of radial "play," replace the sleeve bearing (24) in the hub (20C).

PUMP ASSEMBLY

Before reassembling the pump, inspect all component parts for wear or damage, and replace as required. Wash out the bearing/seal recess of the head and remove any burrs or nicks from the rotor and shaft. Remove any burrs from the liner (41).

1. **LINER** – The liner has a close fit with the casing (12); take care to avoid finger injury during installation.
 - a. Align and start the liner (41) and liner key (74) together into the pump casing. The word "INTAKE," which is cast into the liner, must be towards the intake side of the pump. NOTE: The intake port is marked with an inward facing arrow.
 - b. Lightly tap the outer edge of the liner with a plastic or lead hammer to fully insert it into the casing.
2. **DISC** – Before the disc is attached to the head, make sure both surfaces are clean and smooth. Gently file away any burrs or rough spots.
 - a. Place a disc (71) on the head (20 or 20A) with the counter-bored screw holes facing up.
 - b. Position the disc so that **when the head is mounted** with the drain hole and V-notch down, the word "INTAKE" on the disc will be towards the intake side of the pump. The two disc holes must be in the 2 and 4 o'clock positions if the inlet is on the right (see Figure 10).
 - c. Install the four lockwashers (71B), tangs outward, and machine screws (71 A) to attach the disc to the head.

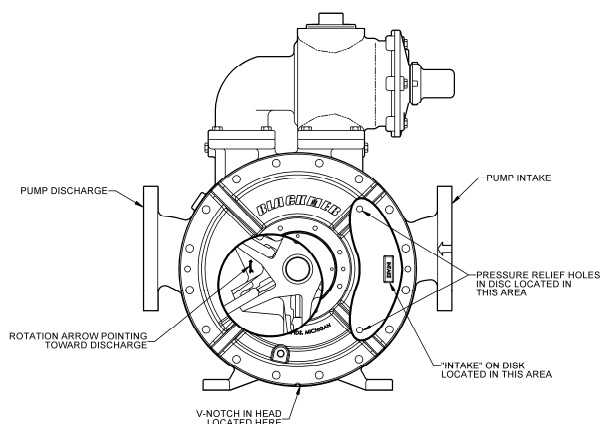

Figure 10

3. **HEAD ASSEMBLY**
 - a. To mount the head assembly (20) to the casing (12), first install the head O-ring (72) in the groove formed where the disc meets the head.
 - b. Grease the entire chamfer on the pump casing where the head O-ring will need to slide into position.
 - c. Place the head assembly (20 or 20A) on the studs, with the V-notch and drain hole facing down (towards the bottom of the pump).
 - d. Check to make sure the word "INTAKE" on the disc is towards the intake side of the pump when the head is mounted.
 - e. Install and tighten the two nuts (21C) on the head studs.

- f. Install and tighten the head capscrews (21) uniformly, making sure the head O-ring (72) slides into place without damage.
4. **SLEEVE BEARINGS (Bushings)** – If the sleeve bearing (24) has been removed from the hub (20C), a new bearing must be installed prior to attaching the hub assembly to the head.
 - a. To aid installation, heat the hub in an oven at 200°F (93°C) before installing the bearing.
 - b. Place the bearing (24) in the bearing bore on the inside face of the hub (20C) with the tapered end inward.
 - c. Using an arbor press, press the bearing into the hub in one continuous motion, until it is flush with (or slightly below) the inside face of the hub. Starting and stopping the pressing motion may result in a cracked bearing.
5. **HUB ASSEMBLY**
 - a. Before attaching the hub assembly (20C) to the mounted head (20), grease the three head chamfers.
 - b. Install the hub O-rings (72A & 72B), and slide the hub (20C) onto the shaft with the V-notch of the hub towards the bottom of the pump.
 - c. Install and tighten the two hub capscrews (21D) to pull the hub into place. BEGIN WORKING ON THE OPPOSITE SIDE OF THE PUMP.
6. **ROTOR AND SHAFT** – It is necessary to install the bottom vanes and the push rods in the rotor while inserting the rotor and shaft into the pump casing.

- a. Partially install the rotor and shaft (13) into the open side of the pump and through the bore of the installed head (20). Be careful not to damage the disc face with the shaft end. **NOTE: When installing the rotor and shaft, the rotation arrow on the rotor must point in the direction of pump rotation-towards the discharge side of the pump when the arrow is positioned directly below the shaft.** See Figure 10.
- b. Keep part of the rotor (13) outside the casing (12) such that the three bottom vanes (14)(rounded edge outward) can be inserted into the rotor slots and held in place while all three push rods (77) are inserted. See Figure 11.
- c. The rotor and shaft (13), with the three bottom vanes (14) installed, can now be **fully** inserted into the casing (12).
- d. Install the remaining vanes (14) in the top positions of the rotor.

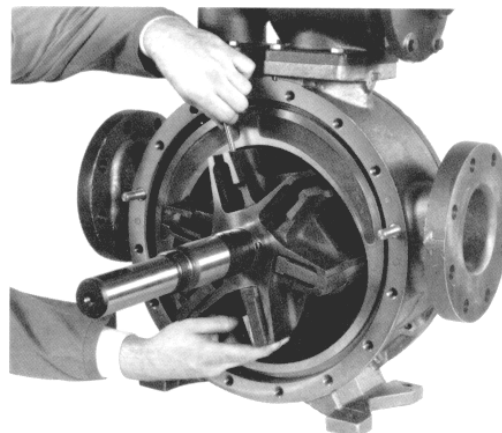

Figure 11

MAINTENANCE: MLN4B, MRLN4B

7. Follow Steps 2 through 5 to install the remaining head and hub assemblies. Remember to grease the casing chamfer and the three head chamfers.
8. **PACKING AND PACKING FOLLOWER**

When necessary to repack, use a full set of new packing rings (19). Packing is furnished in sets with the correct number of rings. Never add new rings to an old set of packing.

 - a. Insert the packing washer (58) into the stuffing box of the inboard hub (20C).
 - b. Insert each packing ring (19) separately into the stuffing box, using the packing follower (75) to properly seat each ring after placement. Be sure to stagger the split joints approximately 180 degrees apart so that they are not overlapping or near the joint of the preceding ring.
 - c. After the packing rings are in place, install and tighten the two packing follower removal nuts (18A) against the hub (20C).
 - d. Place the packing follower (75) snugly against the packing (19). Install the two packing follower stud nuts (18) and tighten lightly.

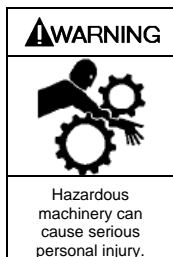

Failure to stop the pump before adjusting the shaft packing can cause severe personal injury.

9. **PACKING ADJUSTMENT** – Packing must be properly adjusted to prevent overheating.
 - a. While the liquid is being pumped, check for leakage from the stuffing box. STOP the pump and uniformly tighten the packing follower stud nuts (18) 1/4 turn at a time to reduce leakage.
 - b. Restart the pump and check the stuffing box temperature several minutes after each adjustment for signs of overheating.
 - c. Check the packing (19) again after 20-30 minutes of running the pump, and readjust if necessary.

NOTE: Some leakage is desirable to lubricate the packing, but in some cases is unacceptable, depending on the application.

10. BLACKMER TRIPLE-LIP SEAL (if equipped)

On pumps equipped with a Blackmer triple-lip seal, refer to the separate literature accompanying the triple-lip seal for installation instructions.

11. COMMERCIAL MECHANICAL SEAL (if equipped)

On pumps equipped with a commercial mechanical seal, refer to the separate literature accompanying the mechanical seal for installation instructions.

12. RELIEF VALVE ASSEMBLY (if equipped)

- a. Insert the valve (9) into the relief valve body (6) with the fluted end inward.
- b. Install the relief valve spring (8), spring guide (7) and guide rod (45) against the valve.
- c. Attach a new relief valve gasket (10) and the valve cover (4) on the cylinder.
- d. Screw the relief valve adjusting screw (2) into the valve cover until it makes contact with the spring guide (7).
- e. Install the relief valve cap (1) and gasket (88) after the relief valve has been precisely adjusted.

NOTICE:

The relief valve setting MUST be tested and adjusted more precisely before putting the pump into service. Refer to "Relief Valve Setting and Adjustment"

13. Reinstall coupling, shaft key (35), and coupling guards.

14. SHAFT COVER

- a. Install the shaft cover O-ring (26) in the groove in the shaft cover.
- b. Lubricate the chamfer on the outboard hub, and slide the shaft cover (27) over the shaft against the hub.
- c. Install and tighten the two shaft cover capscrews (28).



Operation without guards in place can cause serious personal injury, major property damage, or death.

15. Refer to "Pre-Start Up Check List" and "Start Up Procedures" sections of this manual prior to pump operation.

TROUBLESHOOTING

NOTICE:

Maintenance shall be performed by qualified technicians only,
following the appropriate procedures and warnings as presented in this manual.

LEAKAGE

Location

Between the head & casing

Probable Cause/Corrective Action

Damaged head O-ring: Inspect and replace if necessary.
Burrs/dirt in head O-ring groove or casing: File and clean when necessary.

MLX Models - From the tell-tale hole in the hub, or where the hub meets the head.

New Mechanical Seals: New seals may leak slightly at start up, but should seal up shortly thereafter.
Damaged mechanical seals: Check for damaged O-rings or cracked, scratched or worn seal faces
Damaged hub O-rings: Inspect and replace if necessary.

MLN Models - From the seal housing or around the shaft.

Damaged Mechanical Seal: See Above.
Damaged shaft surface: Check the surface of the shaft in the seal area for damage. File any small burrs or ridges. If damage is severe, replace rotor & shaft.

MLN Models - From the stuffing box in the hub.

Packing: Adjust the packing. If this does not solve the problem, replace the packing with a complete new set.
NOTE: On pumps equipped with packing, some leakage is necessary, and in some cases is desirable, depending on the application.

ESCAPING GREASE

Location

MLX Models - Around the pump shaft.

Probable Cause/Corrective Action

Damaged grease seal: Remove the bearing cover and inspect the grease seal for damage. Replace if necessary.

SHAFT BINDING

Probable Cause

Burrs, dirt or foreign particles on the heads or discs.

Corrective Action

During assembly, both heads and discs must be clean and smooth. File any burrs or rough spots, and wipe the discs with a clean cloth and alcohol to remove any dirt or foreign particles.

MLX Models - Improper locknut adjustment.

Locknuts must be adjusted properly to center the rotor and shaft between the heads. Refer to "Locknut Installation" on Page 10.
Refer to "Packing Adjustment" on Page 15.

MLN Models - Excessively tight packing.

MLX & MLN Models - Contaminated mechanical seal faces.

Any trace of grease or dirt on the seal faces will prevent the faces from mating properly, causing the rotor and shaft to bind or turn hard. Use a tissue paper & alcohol to clean the seal faces. NOTE: Apply a light oil or suitable lubricant to bronze seal faces only.

MLX & MLN Models - Mechanical seal drive tangs not engaged.

The driving tangs of the seal jacket must be engaged in the slots in the rotor (MLX Models), or in the keyways of the shaft threads (MLN Models).

OTHER POSSIBLE CAUSES OF SHAFT BINDING:

- Foreign particles on rotor, liner or vanes.
- Damaged vanes or rotor.

- Bent push rods.
 - Liquids that "set up" when inactive.
-

OVERHEATING

Location

Pump equipped with internal relief valve.

Probable Cause/Corrective Action

Continual, full bypassing of the liquid: The relief valve must be adjusted such that the pump will not bypass during normal operation.
WARNING: Internal bypassing of liquid elevates the liquid temperature. Use the internal bypass valve for brief periods only and at differential pressures below 125 psi (8.6 bar). For extended periods of higher pressures, the internal bypass port must be plugged and the liquid returned back to the source.

MLN Models - Stuffing box of hub.

Packing: NEVER tighten packing without checking afterward for overheating. If packing is old or worn, it will overheat – replace with a new packing set.

OTHER POSSIBLE CAUSES OF OVERHEATING:

- Improper relief valve adjustment
(See "Relief Valve" on Page 6).

- Plugged discharge line.
- Closed valve.

TROUBLESHOOTINGcontinued

EXCESSIVE NOISE AND VIBRATION

Probable Cause

Cavitation or vaporization of the liquid resulting from excessive vacuum on the pump due to starved suction.

Entrained air or vapors in the pump.

Rotor & Shaft installed backwards.

Liner Installed Backwards

Pump speeds exceed the recommended maximum.

Continual or long term bypassing of liquid through relief valve.

OTHER POSSIBLE CAUSES OF NOISE AND VIBRATION:

- Excessively worn vanes, liner, or discs.
- Bearing Worn or Damaged.
- Loose or improperly installed piping.

Corrective Action

Check for:

- Inlet piping too long or too small in diameter.
- Strainer plugged or dirty.
- Undersized or restrictive fittings, such as globe valves or partially closed valves.
- Excessive amount of elbows.
- Suction lift too great.
- Pump speed too high for the viscosity of the liquid being pumped.

Check pipe joints for leakage of air. Sometimes when recirculating liquid in a tank, the returning liquid falling through the air carries air down into the tank, which eventually gets back into the pump.

The rotation arrow on the rotor must point towards the discharge port when the arrow is located beneath the shaft.

(See Figure 6 on Page 9 or Figure 10 on Page 14.)

The word "INTAKE", which is cast on the liner MUST be towards the intake side of the pump

Check the recommended RPM for your specific application.

Check for restriction in the discharge line, or an improper relief valve adjustment (See "Relief Valve" on Page 6).

- Misalignment of pump and driver.
- Pump base not properly mounted.
- Insufficient Oil in the Gear Reducer

LOW DELIVERY RATE

Probable Cause

Relief valve setting too low, causing the liquid to bypass.

A dirty strainer.

OTHER POSSIBLE CAUSES OF A LOW DELIVERY RATE:

- Restriction in the suction line.
- Resistance in the discharge line.
- Air leaks in the suction line.
- Damaged or worn pump parts.
- Pump speed too low or too high.

Corrective Action

Set the relief valve 15 - 20 psi (1.0 - 1.4 bar) higher than the differential pressure.

Clean the strainer regularly.

- Rotor & Shaft installed backwards.
- Relief valve leaking.
- Relief valve sticking open, or not properly seating.
- Liner installed backwards

POOR OR NO PRIMING

Probable Cause

- Air leaks in the suction line.
- Restriction in the suction line.
- Damaged or worn pump parts.
- Too much lift for the vapor pressure of the fluid.
- A dirty or clogged strainer.

- Worn vanes.
- Suction Valve Closed.
- Incorrect pump rotation
- Relief Valve partially open, valve not seating properly.

TROUBLESHOOTINGcontinued

DAMAGED VANES

Probable Cause

- Foreign objects entering the pump.
 - Running the pump dry for extended periods of time.
 - Cavitation.
 - Viscosity too high for the vanes and /or the pump speed.
 - Incompatibility with the liquids pumped.
 - Excessive heat.
 - Worn or bent push rods, or worn push rod holes.
 - Settled or solidified material in the pump at start-up.
 - Hydraulic hammer - pressure spikes.
 - Vanes installed incorrectly (see "Vane Replacement").
-

BROKEN SHAFT

Probable Cause

- Foreign objects entering the pump.
 - Viscosity too high for the pump speed.
 - Relief valve not opening.
 - Hydraulic hammer - pressure spikes.
 - Pump/driver, driveline/drive shaft misalignment.
 - Excessively worn vanes or vane slots.
 - Settled or solidified material in the pump at start-up.
 - Overtightened V-belts, if used.
-

SEAL LEAKAGE

Probable Cause

- O-rings not compatible with the liquids pumped.
 - O-rings nicked, cut or twisted.
 - Shaft at seal area damaged, worn or dirty.
 - Ball bearings overgreased.
 - Pump sleeve bearings worn excessively.
 - Excessive cavitation.
 - Mechanical seal faces cracked, scratched, pitted or dirty.
-

MOTOR OVERLOAD

Probable Cause

- Horsepower of motor not sufficient for application
- Improper wire size / wiring and/or voltage to motor.
- Misalignment in pump drive system.
- Excessive viscosity, pressure or speed.
- Bearing locknuts adjusted improperly.
- Faulty or worn bearings.
- Rotor rubbing against head or cylinder.
- Dirty mechanical seal faces.

NOTES

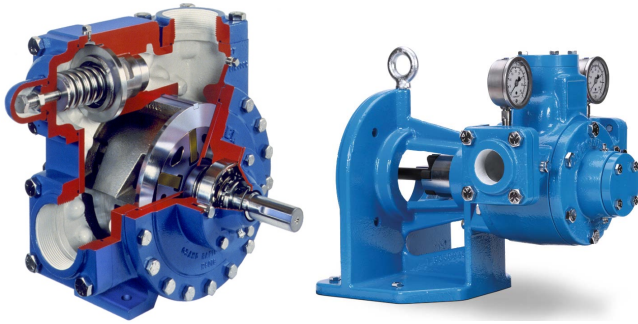

Sliding Vane Pumps: 5 to 2200 GPM
 Refined Fuels, Liquefied Gases, Solvents, Process



Stainless Steel Sliding Vane Pumps
 1 to 265 GPM: Acids, Brines, Sugars, Syrups,
 Beer, Beet Juice, Cider, Flavor Extracts, etc.

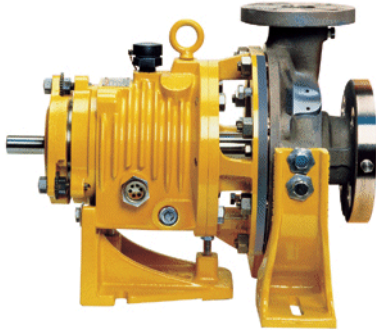

System One® Centrifugal Pumps
 10 to 7500 GPM; Process, Marine



Magnetic Drive Pumps
 Stainless Steel: 14 to 215 GPM

HXL 6, 8 & 10"
 Sliding Vane Pumps
 130 to 2,220 GPM

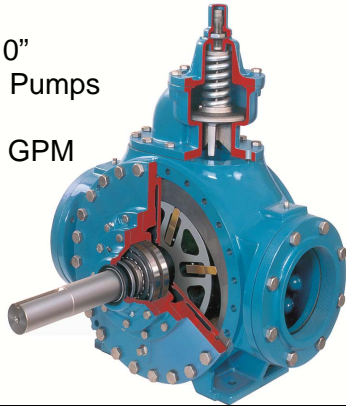

Refineries
 Terminals
 Barges
 Ships



Reciprocating Gas Compressors
 Liquefied Gas Transfer, Boosting, Vapor Recovery



Hand Operated Pumps
 Dispensing, Transfer, In-line



Accessories
 Gear Reducers, Bypass Valves, Strainers

Visit www.blackmer.com for complete information on all Blackmer products



1809 Century Avenue, Grand Rapids, Michigan 49503-1530 U.S.A.

Telephone: (616) 241-1611 • Fax: (616) 241-3752

E-mail: blackmer@blackmer.com • Internet Address: www.blackmer.com